

## An Overview of RedTactonhuman Area Networking Technology

<sup>1</sup>Ms.Tanushree N.Choudhari, <sup>2</sup>Prof. Ms.Bhagyashree Ambulkar

<sup>1</sup>Department Of Computer Science, MCA Sem5, GHRIIT, Nagpur, Maharashtra, India

<sup>2</sup>Department Of Computer Science, GHRIIT, Nagpur, Maharashtra, India

**Abstract:** As, in these days international the communique generation may be very essential to speak with each other. To speak with each other we use gadgets like mobiles, pda's, pagers etc. And numerous networking technologies. Now what about if we should use yourself as a networking era as a RedTacton generation. RedTacton is a HAN (human area networking era) and it became advanced by means of NTT(Nippon Telegraph and cellphone Co-Operation),Japan in 2004. RedTacton transfers statistics 802.3half duplex conversation at the rate of 10 Mb/s. in this era the minute alternate in electric powered area generated with the aid of human because of RedTacton transmitter reasons the statistics switch .RedTacton conversation takes location within the RedTacton transmitter and RedTacton receiver. We will proportion the records thru sports like touching, dancing, gripping, strolling and so forth. it can paintings on numerous a part of body like feet, legs, hands, hands and so forth. and also on garments and footwear. RedTacton is completely safe for human. With the use of RedTacton, we can share records in any medium. RedTacton communication take vicinity inside its transmitter and receiver. It's miles progressive HAN era. HAN is just like the different networking technology like LAN, WAN, guy and so forth. RedTacton era is completely distinctive from infra-crimson and Bluetooth and RFID technology. With the use of progressive RedTacton era we can prepared the unique programs for the use of human beings. RedTacton generation makes use of the human frame as a transmission medium. It's far a destiny technology because of which we are able to switch the records at any location, time. So it will make the data every time and anywhere wanted on the get admission to of fingertips.

**Keywords:**RedTacton, Data, NTT, HAN, Transmission Mediumetc

### I. Introduction

RedTacton is an innovative Human location networking technology (HAN).It turned into advanced by means of Nippon Telegraph and telephone (NTT) at 2004 in Japan. The primary idea in the back of its improvement is frame coupling verbal exchange era. RedTacton call which means is red is an auspicious coloration in an eastern lifestyle and tacton means difficult-and-action.

The facts is transferred as a minute change in susceptible electric field resulting from transmitter within the human body befall. For communique RedTacton transreceiver are required. RedTacton uses minute electric field emitted on human body to switch data. Human frame acts as a transmission medium.it is one-of-a-kind from infra-red, bluetooth, RFID technology which makes use of magnetic –subject, mild for the facts transfer. RedTacton is completely secure for human.

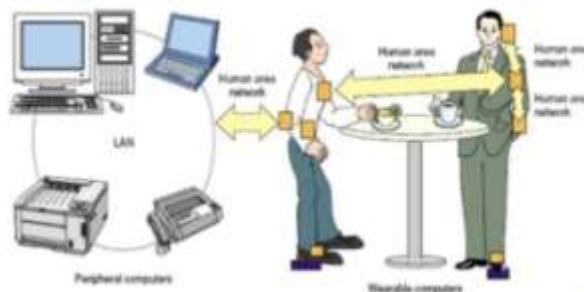

Fig 1.1:- Human and RedTacton Technology.

### II. Literature Assessment

The body coupling communication turned into determined by chance while doing human interface research on position sensors via MIT(T.G.Zimmerman).After there where many researches have been completed on frame coupling communications. The fundamental boundaries in generation causes the disinterest in it of many research organizations. While once more in 2003-2006 again studies accelerate in body coupling

xcommunication. The NTT had done remarkable success to transfer statistics in 1/2 duplex verbal exchange in the pace of 10 Mb/s the usage of an electro-optic implementation.

### III. Operating Of A Redtacton

RedTacton Transmitter induces weak electric area on human frame. RedTacton receiver senses the exchange within the vulnerable electric subject caused by transmitter and transfers the statistics. RedTacton is predicated on the principle that optical homes of an electro-optic crystal can vary according to the change of a vulnerable electric powered area.

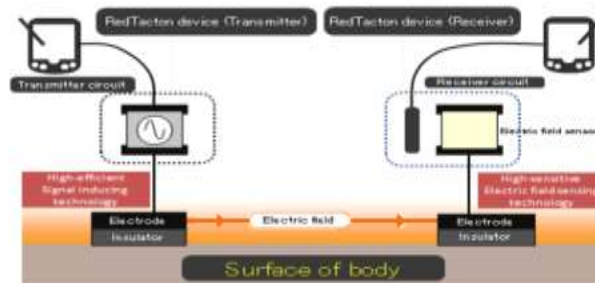

Fig 3.1:-Working of RedTacton

#### I. Mechanism Of Conversation

The photonic electric field sensor detects the change within the vulnerable electric discipline caused by the data transfer. Obviously going on electric area induced on the human body dissipates into the earth consequently, this electric field is relatively faint and risky. The operating precept of RedTacton is  $E_a - E_b - E_c = E_s$  wherein,

$E_a$  is the electrical area induced by way of the transmitter,

$E_b$  is the electric subject returning ground of the transmitter,

$E_c$  is the electric subject on the receiver,

and  $E_s$  is the detected electric powered subject on the receiver.

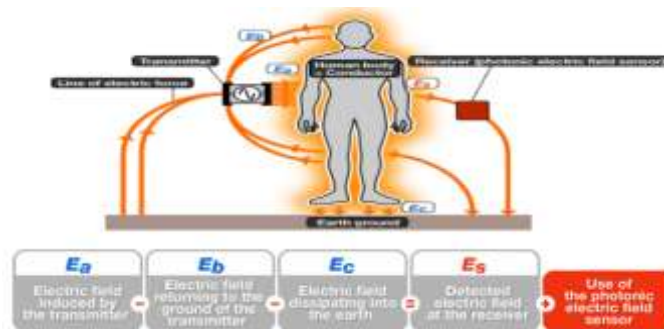

Fig 3.1.1:-Mechanism of Conversation

#### II. REDTACTON TRANSRECEIVER

The signal from interface is ship to the statistics feel circuit and transmitter circuit. The information experience circuit senses the signal and if the information is found in it then sends manage sign to transmitter to activate transmitter circuit. The transmitter induces the vulnerable electric subject on human frame. At the receiver cease, the change in electric powered discipline is sensed with the aid of electro-optic sensor. Its output is given to detect circuit which it offers to interface of receiving device.

The electro-optic sensor has 3 key features:

- It can degree electric powered fields from a tool under take a look at (DUT) without contacting it, which minimizes dimension disturbance.
- Ultra huge-band size is feasible. It supports one-factor contact measurement that is independent of the ground.

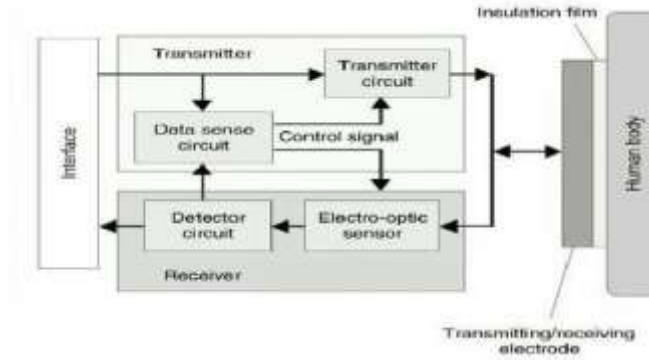

Fig 3.2.1:- RedTacton Transceiver (Block diagram)

**III. HUMAN SAFETY**

No modern flows into human body from RedTacton gadgets. RedTacton makes use of the electrical subject that occurs naturally at the floor of the human body for conversation. Transmitter and Receiver electrodes are covered with insulating movies. RedTacton is in conformity to the “Radio –Frequency publicity protection standard (RCR STD-38)” by way of the affiliation Of Radio Industries andBusiness (ARIB).



Fig 3.3:-ARIB Standard

**IV. REDTACTON FIRMWARE**

From the hardware point of view, the multiple module is some other call for RedTacton Module. RedTacton Firmware is placed inside the virtual LSI(massive-Scale incorporated Circuit) a part of the RedTacton module and it has electric-subject communication interface and stressed communique interface. The gateway of RedTacton module through the analog LSI a part of it’s module is electrical area communique interface. The gateway of supervising gadgets are wired communication interface.

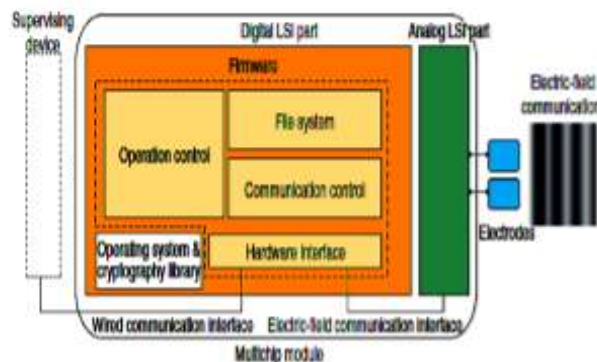

Fig 3.4 Structure of Firmware

**V. Capabilities Of Redtacton**

1. Contact: -Touching, gripping, walking and other human activities can be occasion to begin or stopping device acquiring statistics.
2. Broadband and Interactive: -As the transmission path is human body the transmission pace does not become worse in congested regions.
- 3.Any Media: -RedTacton can make use of extensive variety of fabric as transmission medium. It is able to be metal, dielectric, water, glass, plastic, and many others.

### VI. Comparison With Different network

Inside the fig. it absolutely indicates that RedTacton is the high-quality generation within the counted of the remaining meter connectivity. It's far placed as 1m approach to remaining close range conversation.

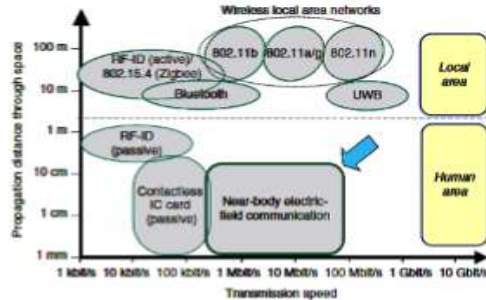

Fig 5. Comparison with other network

### VII. Applications

**1. User verification and unlocking with only a contact:**

Wearing a cellular purple Tacton capable tool in a single’s pocket, identity is showed and the door unlocked while the individual holds the doorknob normally. Cozy lock management is feasible by way of combining private verification gear together with fingerprint identification or extraordinary biometric within the cellular terminal.

**2. Computerized get right of access to log:**

There additionally a facility to get right of access to computerized log for non-public record storage. The ones get proper of entry to logs contain database records in the form of log documents.

**3. Under Water conversation:**

T2T permits conversation in outer area and in water in which the speech constraints are very immoderate and therefore lets in an exceedingly efficient manner of expression of speech that is past the purvey of humans.

**4. Personalization:**

There are numerous applications underneath personalization... just touching a smartphone makes it your very own cellphone wide range is allocated and billing commences. Automated importing of personal deal with e-book and get in touch with records.

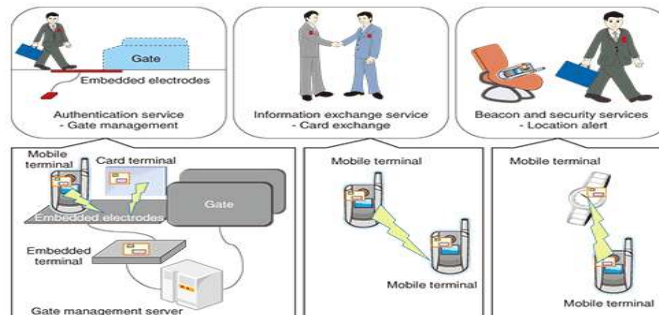

Fig 6. Applications of RedTacton

### VIII. Advantages

- RedTacton does no longer require the electrode be in direct touch with the pores and skin.
- Excessive-velocity conversation is viable between two arbitrary factors at the frame.
- Body-based networking is greater cozy than broadcast systems, along with Bluetooth which have high variety of about 10m.
- Network congestion due to fall in transmission velocity in multiuser environments is avoided.

- Superior than Infrared technology
- Advanced than wireless.
- Records loss at some point of transfer is much less.
- Use of minimum amount of strength (of some mill volt variety).

### **IX. Limitations**

- The maximum obvious barrier to entry is that the fee and time to develop non-public location community technology is very high-priced.
- As a new technology private place networks need to benefit popularity amongst users to help pull the era into the marketplace alternatively of having it driven upon them.
- Additionally, extensive advertising campaigns will need to be developed to highlight the blessings of PAN generation to facilitate its adoption.
- Eventually, this generation will no longer possibly be very useful until a big wide variety of humans and devices have followed it this means that a large time investment.

### **X. Future Scope**

RedTacton is secure generation as it can't be hacked. So it may be used to ship private information of army, protection. It could be used as keys, card, and so on. And additionally for the personalization. As the era is still developing generation so there are numerous aspects in which the generation can be used. The any media function can permit us to transmit the information underneath water, and many others. It is able to be used in navy, clinical packages and so forth.

### **Conclusion**

RedTacton is higher than every other era in closing meter connectivity. Its miles satisfactory to attach network inside short distance. It is able to overtake Bluetooth era. Crimson Tacton is still developing so we are able to conclude that it is a destiny technology.

### **References**

- [1]. wikipedia.RedTacton[Online].Available:<http://en.wikipedia.org/wiki/RedTacton>
- [2]. .NTT (February 2005). "RedTacton: An innovative Human Area Networking technology.
- [3]. Prof. VasantkumarUpadhye and Pooja C Kallatti,"Redtacton", International Journal of New Innovations in Engineering and Technology, Volume4Issue March 2016 ISSN : 2319-6319
- [4]. M.Jadhav, KrushnkumarA.Bhanuse, Chetan S.Lokhande and Ms. A. A. Pujari, "Data Transfer Through Human Body using REDTACTON",INTERNATIONAL JOURNAL FOR RESEARCH IN EMERGING SCIENCE AND TECHNOLOGY, VOLUME-3, ISSUE-3, MAR-2016, E-ISSN: 2349-7610
- [5]. Ashutoshkumar, M.V.N.R. Pavan Kumar, UtkarshKamble, Mahesh Dhebe , Amol Khot, "Overview on RedTacton Technology",Internatrch in Advent Technology, Vol.2, No.4, April 2014 E-ISSN: 2321-9637
- [6]. [https://scholar.google.co.in/scholar?q=ieeee+research+paper+redtacton+human+area+networking+technology&hl=en&as\\_sdt=0&as\\_vis=1&oi=scholart](https://scholar.google.co.in/scholar?q=ieeee+research+paper+redtacton+human+area+networking+technology&hl=en&as_sdt=0&as_vis=1&oi=scholart)